

Proportional relief valves type RZMO-AES

direct operated, without integral pressure transducer, ISO 4401 size 06

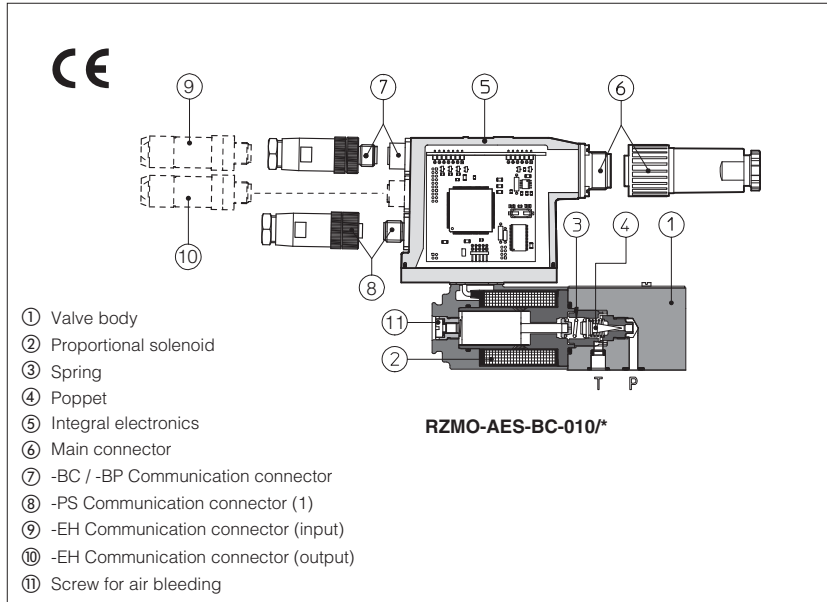

RZMO are poppet type proportional pressure relief valves, direct operated without integral pressure transducer, which provide pressure regulation proportional to electronic reference signals.

They operate in association with electronic drivers, see section 2, which supply the proportional valve with proper current to align valve regulation to the reference signal supplied to the electronic driver.

They are available in different executions:

- -A, without integral pressure transducer.
- -AE, -AES, as -A plus analogue (AE) or digital (AES) integral electronics ⑤.

The system pressure is controlled by the poppet ④, directly operated by the proportional solenoid ② and the spring ③.

The integral electronics ⑤ ensures factory presetting, fine functionality plus valve-to-valve interchangeability and simplified wiring and installation.

The electronic main connector ⑥ is fully interchangeable for -AE and -AES executions. Standard 7 pin connector is used for power supply, analog input reference and monitor signals. 12 pin connector is used for option /Z (AES).

Following communication interfaces ⑦, ⑧, ⑨, ⑩ are available for the -AES execution:

- -PS, Serial communication interface for configuration, monitoring and firmware updating through Atos PC software - always present also for -BC, -BP and -EH options
- -BC, CANopen interface
- -BP, PROFIBUS-DP interface
- -EH, EtherCAT interface

The valves with -BC and -BP interfaces can be integrated into a fieldbus communication network and thus digitally operated by the machine control unit.

The coils are fully plastic encapsulated with insulation class H.

Mounting surface: ISO 4401, size 06
Max flow: 4 l/min
Max pressure: 350 bar.

1 MODEL CODE

RZMO	-	AES	-	PS	-	010	/	315	/	*	/	**	/	*
<p>Proportional pressure relief valve size 06</p> <p>A = without integral transducer AE = as A plus integral electronics AES = as A plus integral digital electronics</p> <p>Communication interfaces (only for AES): PS = Serial (1) BC = CANopen BP = PROFIBUS DP EH = EtherCAT</p> <p>Configuration: 010 = regulation on port P, discharge in T</p> <p>Pressure range: 50 = 50 bar 100 = 100 bar 210 = 210 bar 315 = 315 bar 350 = 350 bar</p> <p>Seals material: omit for NBR (mineral oil & water glycol) PE = FPM</p> <p>Series number</p> <p>Coil voltage (only for -A execution) see section 7: - = standard coil for 24V_{DC} Atos drivers 6 = optional coil for 12V_{DC} Atos drivers 18 = optional coil for low current drivers</p> <p>Electronics options for -AE execution, see section 9: I = current reference input (4÷20 mA) Q = enable signal</p> <p>Electronics options for -AES execution, see section 11: Q = enable signal Z = adds double power supply, enable and fault signals (12 pin connector)</p>														

(1) Serial communication interface always present, also for -BC, -BP and -EH options

2 ELECTRONIC DRIVERS FOR RZMO

Valve model	-A						-AE	-AES
Drivers model	E-MI-AC-01F	E-MI-AS-IR	E-BM-AC-01F	E-BM-AS-PS	E-ME-AC-01F	E-RP-AC-01F	E-RI-AE	E-RI-AES
Data sheet	G010	G020	G025	G030	G035	G100	G110	G115

Note: for power supply and communication connector see section 14

3 HYDRAULIC CHARACTERISTICS (based on mineral oil ISO VG 46 at 50 °C)

Hydraulic symbols						
Valve model	RZMO-A		RZMO-AE RZMO-AES			
Max regulated pressure (Q = 1 l/min)	[bar]	50	100	210	315	350
Min. regulated pressure (Q = 1 l/min)	[bar]	1	1,8	2,5	3,5	3
Max. pressure at port P	[bar]				350	
Max. pressure at port T	[bar]				210	
Max. flow	[l/min]				4	
Response time 0-100% step signal (depending on installation)	[ms]				≤70	
Hysteresis [% of the max pressure]					≤1,5	
Linearity [% of the max pressure]					≤3	
Repeatability [% of the max pressure]					≤2	

Above performance data refer to valves coupled with Atos electronic drivers, see section 2.

4 MAIN CHARACTERISTICS

Assembly position	Any position
Subplate surface finishing	Roughness index Ra 0,4 - flatness ratio 0,01/100 (ISO 1101)
Ambient temperature	-20°C ÷ +70°C for -A execution; -20°C ÷ +60°C for -AE and -AES executions
Fluid	Hydraulic oil as per DIN 51524 ... 535 for other fluids see section 1
Recommended viscosity	15 ÷ 100 mm ² /s at 40°C (ISO VG 15÷100)
Fluid contamination class	ISO 4406 class 20/18/15 NAS 1638 class 9, in line filters of 10 µm (β10 ≥75 recommended)
Fluid temperature	-20°C +60°C (standard seals) -20°C +80°C (/PE seals)
Coil resistance R at 20°C	3 ÷ 3,3 Ω for standard; 2 ÷ 2,2 Ω for option /6; 13 ÷ 13,4 Ω for option /18
Max solenoid current	2,6 A for standard 12 V _{DC} coil; 3,25 A for 6 V _{DC} coil; 1,5 A for 18 V _{DC} coil
Max power	30 Watt for -A execution; 50 Watt for -AE and AES executions
Protection degree (CEI EN-60529)	IP65 for -A execution; IP67 for -AE and AES executions
Duty factor	Continuous rating (ED=100%)

5 DIAGRAMS (based on mineral oil ISO VG 46 at 50 °C)

5.1 Regulation diagrams with flow rate Q = 1 l/min

1 = RZMO-A, RZMO-AE, RZMO-AES

Note:

The presence of counter pressure at port T can affect the effective pressure regulation.

5.2 Pressure/flow diagrams with reference signal set at Q = 1 l/min

2 = RZMO-A, RZMO-AE, RZMO-AES

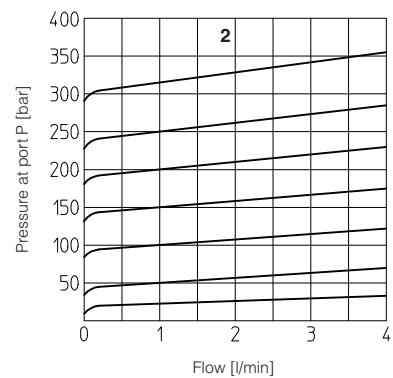
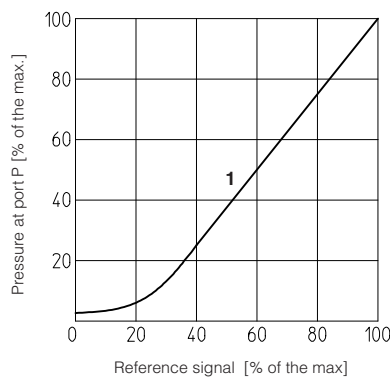

5.3 Min. pressure/flow diagrams with zero reference signal

3 = RZMO-*-010/50
4 = RZMO-*-010/100
5 = RZMO-*-010/210
6 = RZMO-*-010/315
7 = RZMO-*-010/350

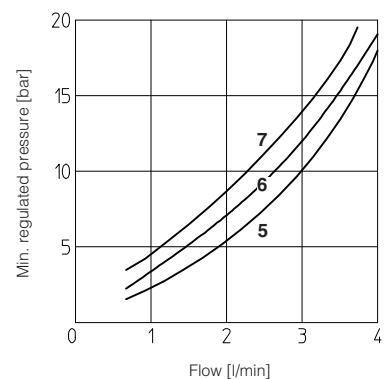
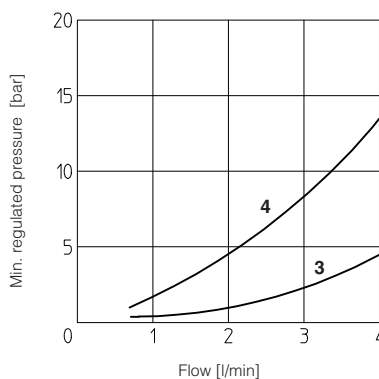

5.4 Dynamic response

The response times in section 3 have to be considered as average values.

The pressure variation in consequence of a modification of the reference input signal to the valve is affected by the stiffness of the hydraulic circuit: greater is the stiffness of the circuit, faster is the dynamic response.

6 GENERAL NOTES

RZMO proportional valves are CE marked according to the applicable Directives (e.g. Immunity/Emission EMC Directive and Low Voltage Directive).

Installation, wirings and start-up procedures must be performed according to the general prescriptions shown in table F003 and in the installation notes supplied with relevant components.

The electrical signals of the valve (e.g. monitor signals) must not be directly used to activate safety functions, like to switch-ON/OFF the machine's safety components, as prescribed by the European standards (Safety requirements of fluid technology systems and components-hydraulics, EN-982).

7 OPTIONS FOR -A EXECUTION

7.1 Option /6 optional coil to be used with Atos drivers with power supply 12 Vdc

7.2 Option /18 optional coil to be used with electronic drivers not supplied by Atos

8 CONNECTIONS FOR -A EXECUTION

SOLENOID POWER SUPPLY CONNECTOR	
PIN	Signal description
1	SUPPLY
2	SUPPLY
3	GND

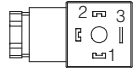

9 ANALOG INTEGRAL DRIVERS -AE - OPTIONS

Standard driver execution provides on the 7 pin main connector:

Power supply - 24Vdc must be appropriately stabilized or rectified and filtered; a 2,5 A safety fuse is required in series to the driver power supply. Apply at least a 10000 µF/40 V capacitance to single phase rectifiers or a 4700 µF/40 V capacitance to three phase rectifiers

Reference input signal - analog differential input with 0÷+10Vdc nominal range (pin D, E), proportional to desired coil current

Monitor output signal - analog output signal proportional to the actual valve's coil current (1V monitor = 1A coil current)

Following options are available to adapt standard execution to special application requirements:

9.1 Option /I

It provides the 4÷20 mA current reference signal instead of the standard 0÷+10 Vdc. Monitor output signal is still the standard 0÷+10Vdc.

It is normally used in case of long distance between the machine control unit and the valve or where the reference signal can be affected by electrical noise; the valve functioning is disabled in case of reference signal cable breakage.

9.2 Option /Q

It provides the possibility to enable or disable the valve functioning without cutting the power supply (the valve functioning is disabled but the driver current output stage is still active). To enable the driver supply a 24Vdc on the enable input signal.

9.3 Possible combined option: /IQ

10 ANALOG INTEGRAL DRIVERS -AE - MAIN FUNCTIONS AND ELECTRONIC CONNECTIONS

MAIN CONNECTOR
7 PIN - STANDARD

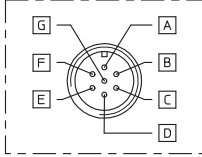

Selector SW				Dither frequency [Hz]
SW1	SW2	SW3	SW4	
				100
ON				130
	ON			160
		ON		200 (Standard)
ON		ON		230
	ON	ON		270
ON	ON	ON		300
ON	ON		ON	380
ON		ON	ON	430
	ON	ON	ON	470
ON	ON	ON	ON	500

The dither frequency is factory preset at 200 Hz and its regulation may be adjusted after contact with Atos technical department

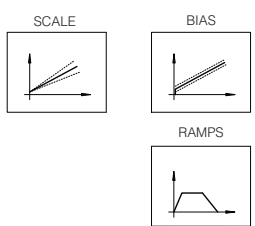

REGULATIONS AND SWITCHES
(remove the rear cover)

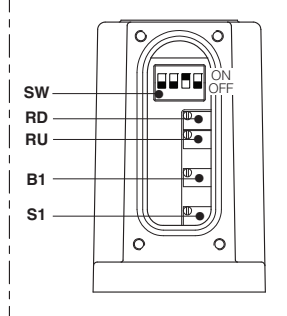

B1: positive bias adjust
S1: positive scale adjust
RU: ramp for increasing reference signal
RD: ramp for decreasing reference signal
SW: dither frequency selector (see table beside)

10.1 7 PIN MAIN CONNECTOR

PIN	SIGNAL	TECHNICAL SPECIFICATIONS	NOTES
A	V+	Power supply 24 Vdc for solenoid power stage and driver logic	Input - power supply
B	V0	Power supply 0 Vdc for solenoid power stage and driver logic	Gnd - power supply
C ⁽¹⁾	AGND	Ground - signal zero for MONITOR signal	Gnd - analog signal
	ENABLE	Enable (24 Vdc) or disable (0 Vdc) the driver (for /Q option)	Input - on/off signal
D	INPUT+	Reference analog input: 0÷+10 Vdc maximum range (4 ÷ 20 mA for /I option)	Input - analog signal
E	INPUT -	Normal working range 0÷+10 Vdc (4 ÷ 20 mA for /I option)	
F	MONITOR	Monitor analog output: 0÷+5 Vdc maximum range; 1 V = 1 A	Output - analog signal
G	EARTH	Internally connected to the driver housing	

Note: (1) with /Q option ENABLE signal replaces AGND on pin C; MONITOR signal is referred to pin B.

A minimum time of 60ms to 160ms have to be considered between the driver energizing with the 24 Vdc power supply and when the valve is ready to operate. During this time the current to the valve coils is switched to zero

11 DIGITAL INTEGRAL DRIVERS -AES - OPTIONS

Standard driver execution provides on the 7 pin main connector:

- Power supply** - 24Vdc must be appropriately stabilized or rectified and filtered; a 2,5 A safety fuse is required in series to each driver power supply
Apply at least a 10000 μ F/40 V capacitance to single phase rectifiers or a 4700 μ F/40 V capacitance to three phase rectifiers.
- Reference input signal** - analog differential input with 0÷+10 Vdc nominal range (pin D, E), proportional to desired coil current (4÷20 mA with cable break detection, \pm 10 mA, \pm 20 mA or 0÷20 mA software selectable)
- Monitor output signal** - analog output signal proportional to the actual valve's coil current (1V monitor = 1A coil current)

Following options are available to adapt standard execution to special application requirements:

11.1 Option /Q

To enable the driver, supply 24Vdc on pin C referred to pin B: when the enable signal is set to zero the valve status is software selectable, by factory default the valve functioning is disabled (zero current to the solenoid) but the driver current output stage is still active. For the complete list of selectable status, see tab. G115.

11.2 Option /Z

It provides, on the 12 pin main connector, the following additional features:

Logic power supply

Separated power supply for the solenoid (pin 1, 2) and for the digital electronic circuits (pin 9, 10).

Cutting solenoid power supply allows to interrupt the valve functioning but keeping energized the digital electronics thus avoiding fault conditions of the machine fieldbus controller. This condition allows to realize safety systems in compliance with European Norms EN13849-1 (ex EN954-1).

Enable Input Signal

To enable the driver, supply 24Vdc on pin 3 referred to pin 2: when the enable signal is set to zero the valve status is software selectable, by factory default the valve functioning is disabled (zero current to the solenoid) but the driver current output stage is still active. For the complete list of selectable status, see tab. G115.

Fault Output Signal

Fault output signal indicates fault conditions of the driver (solenoid short circuits/not connected, reference signal cable broken for 4÷20mA input, etc.). Fault presence corresponds to 0 Vdc, normal working corresponds to 24Vdc (pin 11 referred to pin 2): Fault status is not affected by the Enable input signal.

12 DIGITAL INTEGRAL DRIVERS -AES, -PS, -BC, -BP - MAIN FUNCTIONS AND ELECTRONIC CONNECTIONS

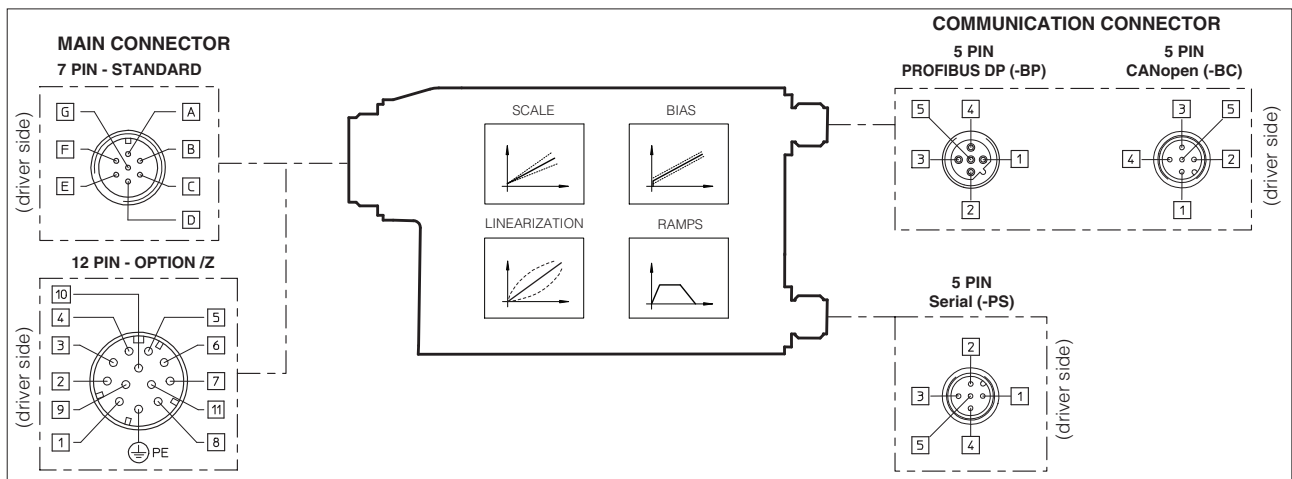

12.1 7 OR 12 PIN MAIN CONNECTOR

Standard 7pin	/Z option 12pin	SIGNAL	TECHNICAL SPECIFICATIONS	NOTES
A	1	V+	Power supply 24 Vdc for solenoid power stage (and for driver logic on 7 pin connection)	Input - power supply
B	2	V0	Power supply 0 Vdc for solenoid power stage (and for driver logic on 7 pin connection)	Gnd - power supply
D	4	INPUT+	Reference analog input: \pm 10 Vdc / \pm 20 mA maximum range software selectable, see [9]	Input - analog signal
E	-	INPUT -	Default setting 0÷+10 Vdc differential input /Z option: common mode INPUT+ referred to AGND	
C	3	ENABLE	Enable (24 Vdc) or disable (0 Vdc) the driver	Input - on/off signal
	5	AGND	Ground - signal zero for MONITOR signal signal zero for INPUT+ signal (only for /Z option)	Gnd - analog signal
F	6	MONITOR	Monitor analog output: 0÷+5 Vdc maximum range; 1 V = 1 A	Output - analog signal
-	7	NC	do not connect	
-	8	NC	do not connect	
-	9	VL+	Power supply 24 Vdc for driver logic	Input - power supply
-	10	VLO	Power supply 0 Vdc for driver logic	Gnd - power supply
-	11	FAULT	Fault (0 Vdc) or normal working (24 Vdc)	Output - on/off signal
G	PE	EARTH	Internally connected to the driver housing	

Note: A minimum time of 270 to 340 ms have be considered between the driver energizing with the 24Vdc power supply and when the valve is ready to operate. During this time the current to the valve coils is switched to zero.

12.2 5 PIN M12 COMMUNICATION CONNECTORS

Serial (-PS)			CANopen (-BC)		PROFIBUS DP (-BP)	
PIN	SIGNAL	TECHNICAL SPECIFICATION	SIGNAL	TECHNICAL SPECIFICATION	SIGNAL	TECHNICAL SPECIFICATION
1	NC	do not connect	CAN_SHLD	Shield	+5V	for termination
2	NC	do not connect	NC	do not connect	LINE-A	Bus line (high)
3	RS_GND	Signal zero data line	CAN_GND	Signal zero data line	DGND	data line and termination Signal zero
4	RS_RX	Valves receiving data line	CAN_H	Bus line (high)	LINE-B	Bus line (low)
5	RS_TX	Valves transmitting data line	CAN_L	Bus line (low)	SHIELD	do not connect

13 DIGITAL INTEGRAL DRIVER -AES-EH - MAIN FUNCTIONS AND ELECTRONIC CONNECTIONS

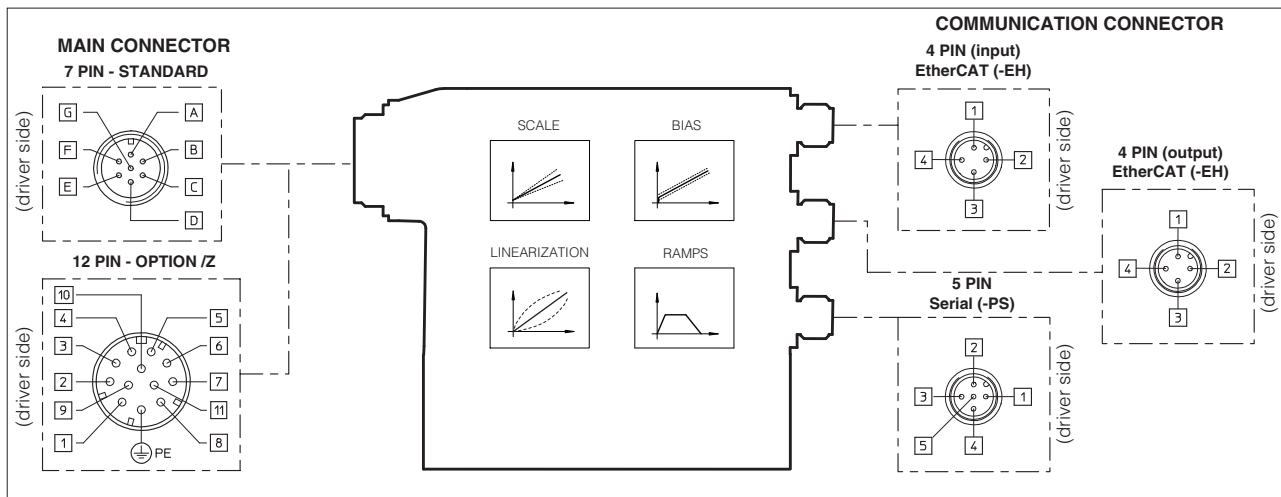

Note: for the electronic connections of 7 or 12 pin main connector, see section 12.1

13.1 4 & 5 PIN M12 COMMUNICATION CONNECTORS

Serial (-PS)		
PIN	SIGNAL	TECHNICAL SPECIFICATION
1	NC	do not connect
2	NC	do not connect
3	RS_GND	Signal zero data line
4	RS_RX	Valves receiving data line
5	RS_TX	Valves transmitting data line

EtherCAT (-EH)		
PIN	SIGNAL	TECHNICAL SPECIFICATION
1	TX+	Transmitter
2	RX+	Receiver
3	TX-	Transmitter
4	RX-	Receiver
Housing	Shield	Positioned on control cabinet side

14 MODEL CODES OF POWER SUPPLY AND COMMUNICATION CONNECTORS (to be ordered separately)

VALVE VERSION	-A	-AE, -AES		-AES/Z	-Serial (-PS) or CANopen (-BC)	PROFIBUS DP (-BP)	EtherCAT (-EH)
CONNECTOR CODE	666	ZH-7P	ZM-7P	ZH-12P	ZH-5P	ZH-5P/BP	ZM-4PM/EH
PROTECTION DEGREE	IP65	IP67	IP67	IP67	IP67	IP67	IP67
DATA SHEET	K500	G110, G115, K500			G115, K500		

 connectors supplied with the valve

15 PROGRAMMING TOOLS - see tech table GS500

Valve's functional parameters and configurations, can be easily set and optimized using Atos E-SW programming software connected to the digital driver. E-SW software is available in different versions according to the driver's communication interface: PS (Serial) E-SW-PS, BC (CANopen) E-SW-BC and BP (PROFIBUS DP). Proportional valves with fieldbus communication interface can be directly managed by the machine control unit; it is required to implement in the machine control the standard communication as described in the user manuals supplied with the relevant programming software.

ISO 4401: 2005

Mounting surface: 4401-03-02-0-05 (see table P005)
(without ports A and B)

Fastening bolts:

4 socket head screws M5X50 class 12.9

Tightening torque = 8 Nm

Seals: 2 OR 108

Ports P, T: $\varnothing = 5$ mm

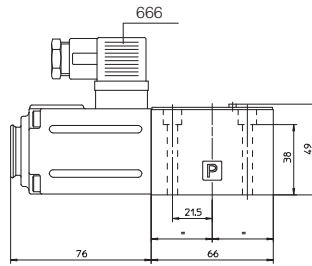

RZMO-A

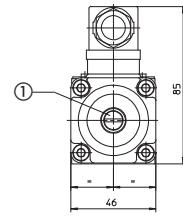

Mass: 1,8 Kg

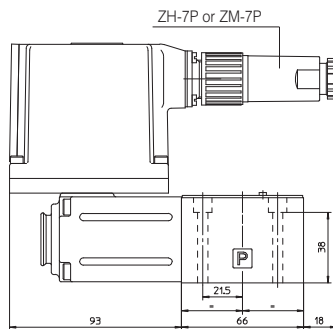

RZMO-AE

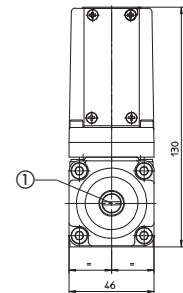

Mass: 2,5 Kg

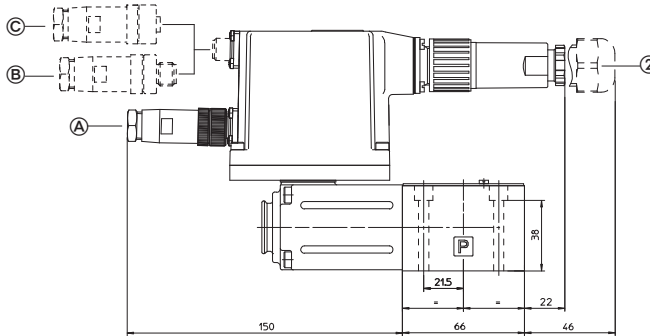

RZMO-AES (-PS, -BP, -BC)

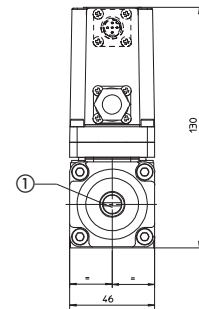

Mass: 2,7 Kg

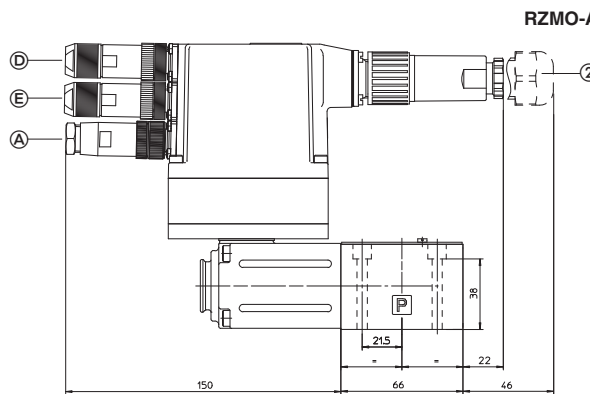

RZMO-AES (-EH)

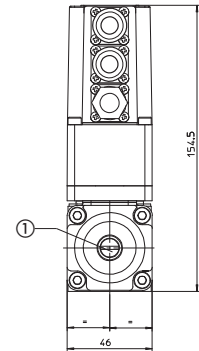

Mass: 2,8 Kg

- Ⓐ -PS communication interface, ZH-5P connector
- Ⓑ -BP communication interface, ZH-5P/BP connector
- Ⓒ -BC communication interface, ZH-5P connector
- Ⓓ -EH communication interface (input), ZM-4PM/EH connector
- Ⓔ -EH communication interface (output), ZM-4PM/EH connector

- ① = screw for air bleeding
- ② dotted line = 12 pin connector ZH-12P for option /Z